



DSI2598+

自動化生理量測及監控

設計者：張軒翊

指導單位：經濟部工業局

執行單位：資策會數位服務創新研究所

發想動機



摘要



硬體介紹



程式介紹



成果展示

第一章

摘要

1-1 案例簡介與應用

1-2 所需材料



I - I 案例簡介與應用

智慧醫療為目前科技發展重點之一，其目的為減少人力耗損及提升醫院服務效率。在台灣醫療院所時常有人手不足及繁忙的情況，進而導致護理師及病人雙方之壓力。本範例利用自動化生理量測來減少護理人員對病患繁複的測量工作。因此利用心跳血氧感測器測量病患生理數值，再利用DSI2598+開發板回傳感測器參數，以做出數值監控，數值有問題時(心跳過高)DSI2598+開發板驅動蜂鳴器提醒護理人員有異常狀況，使護理師能遠端查看病人之心跳狀態並對異常狀態做出應對。

案例簡介與應用

示意圖

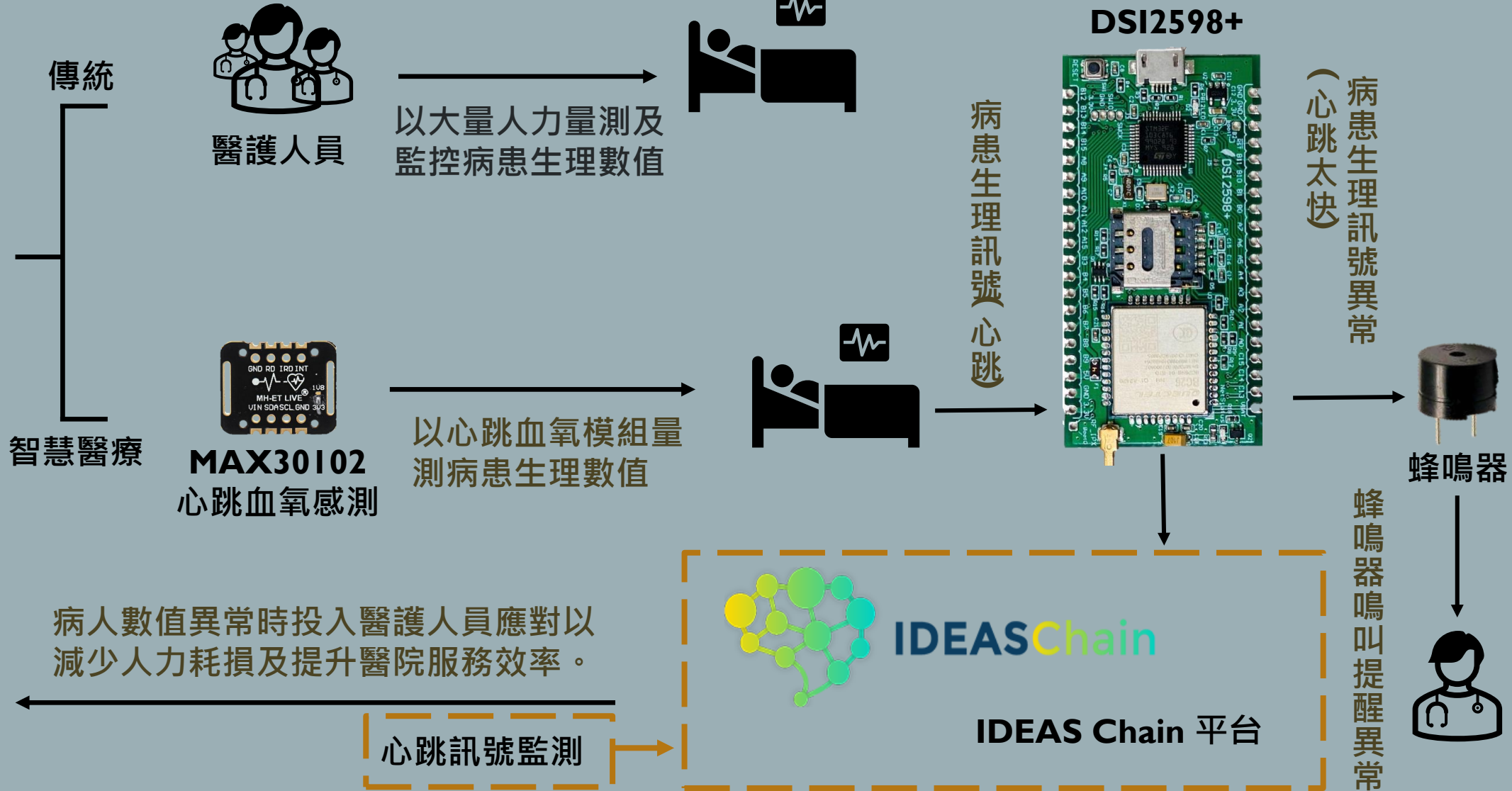



I-2 所需材料

1. **DSI2598+ x1**
2. **MAX30102心跳血氧感測器x1**
3. **排線x少許**

第二章

硬體介紹

2-1 DSI2598+基礎介紹

2-1-1 腳位介紹

2-1-2 接線介紹

*感測器介紹

2-2 MAX30102心跳血氧感測器

2-1 DSI2598+基礎介紹



- NB-IoT使用MTK MT2625晶片
- STM32 F103 32 bit核心
- 相容Arduino IDE開發環境
- Keil C / STM32Cube 開發環境
- 多種韌體燒錄方式
- 更多功能腳位，12 bit ADC解析度
- 郵票式電路板和排針雙用模組設計，可使用排針或直接SMT在主板上
- 內含時鐘功能(RTC)

2-1-1 腳位介紹

為了控制NBIOT BC26 通訊模組，下面列的PIN，盡量不要與其他功能並用:
 PA10(Serial1.RXD) <- BC26.TX
 PA9(Serial1.TXD) -> BC26.RX
 PC13(OUTPUT) -> BC26.RESET(Low active)

LEGEND	
POWER	
GROUND	
PHYSICAL PIN	
PIN NAME	
CONTROL	
ANALOG	
TIMER & CHANNEL	
USART	
SPI	
I2C	
CAN BUS	
USB	
MISC	
BOARD HARDWARE	
	5V tolerant
	Not 5V tolerant
	PWM pin
	Alternate function
	PC13,PC14,PC15: Sink max 3mA, Source 0mA, Max 2mHz, Max30pF
Absolute MAX 150mA total source/sink for entire CPU	
Max ±20mA per pin, ±8mA recommend	

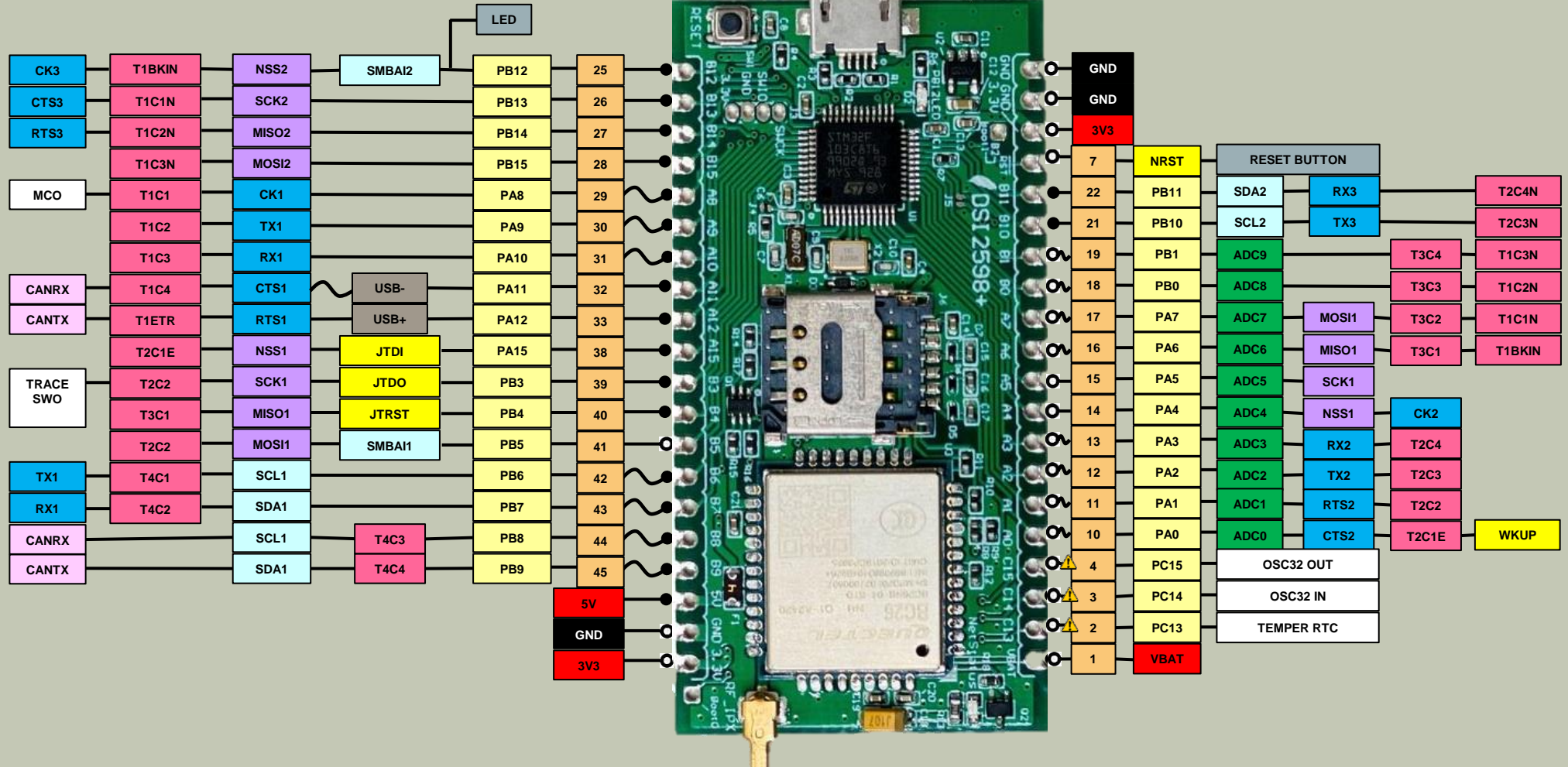



2-1-2 接線介紹

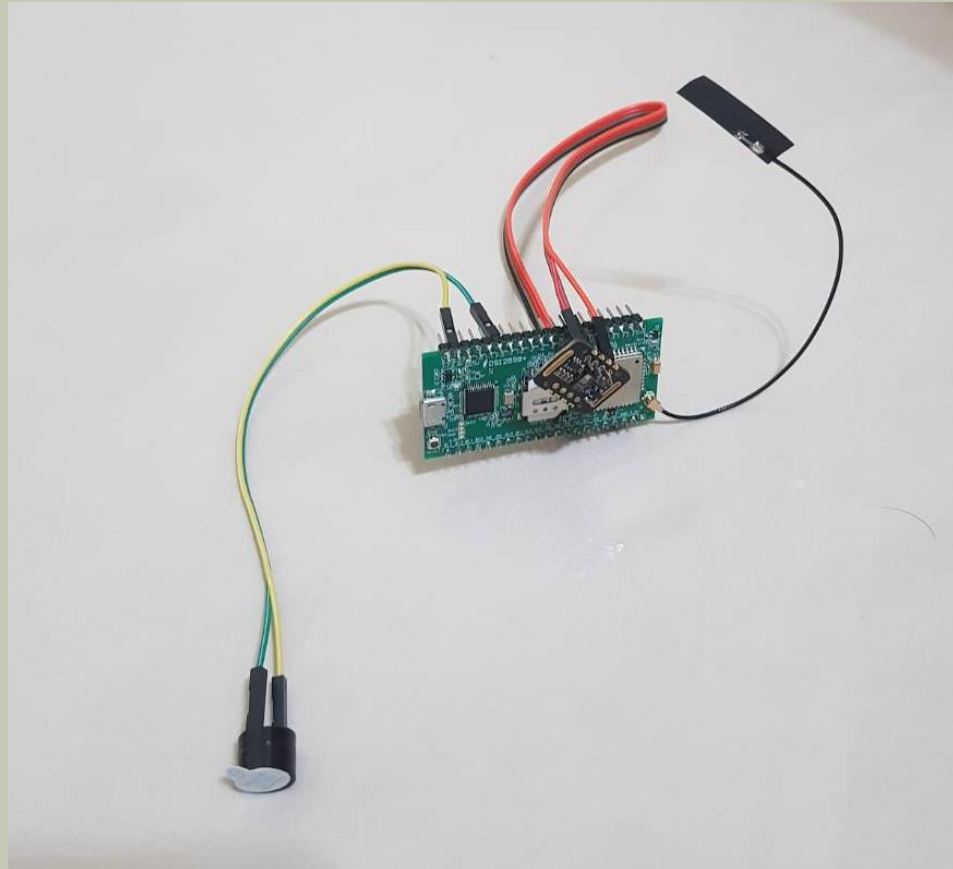

本次範例之連接圖如左

使用元件分別為：

1. DSI2598+ x1
2. MAX30102心跳血氧感測器
3. 排線x少許

2-2 感測器介紹- MAX30102

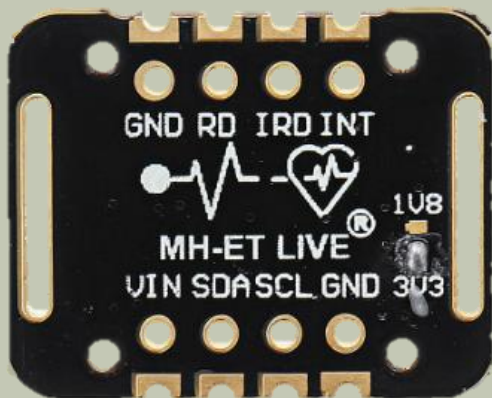

工作資訊：

- LED峰直波長:660nm/880nm
- LED供電電壓:3.3~5V
- 檢測信號類型:光反射信號(PPG)
- 輸出信號街口:I2C接口
- 通信接口電壓:1.8~3.3V~5V(可選)
- VIN:主電源電源輸入端.1.8V~5V
- SCL:接I2C總線的時鐘
- SDA:接I2C總線的數據
- GND:接地線

第三章

軟體介紹

3-1 開發環境及APN設定

3-1-1 平台設定及配置

*程式介紹

3-2-1 BC26_init.h

3-2-2 main.ino

3-1 開發環境及APN設定

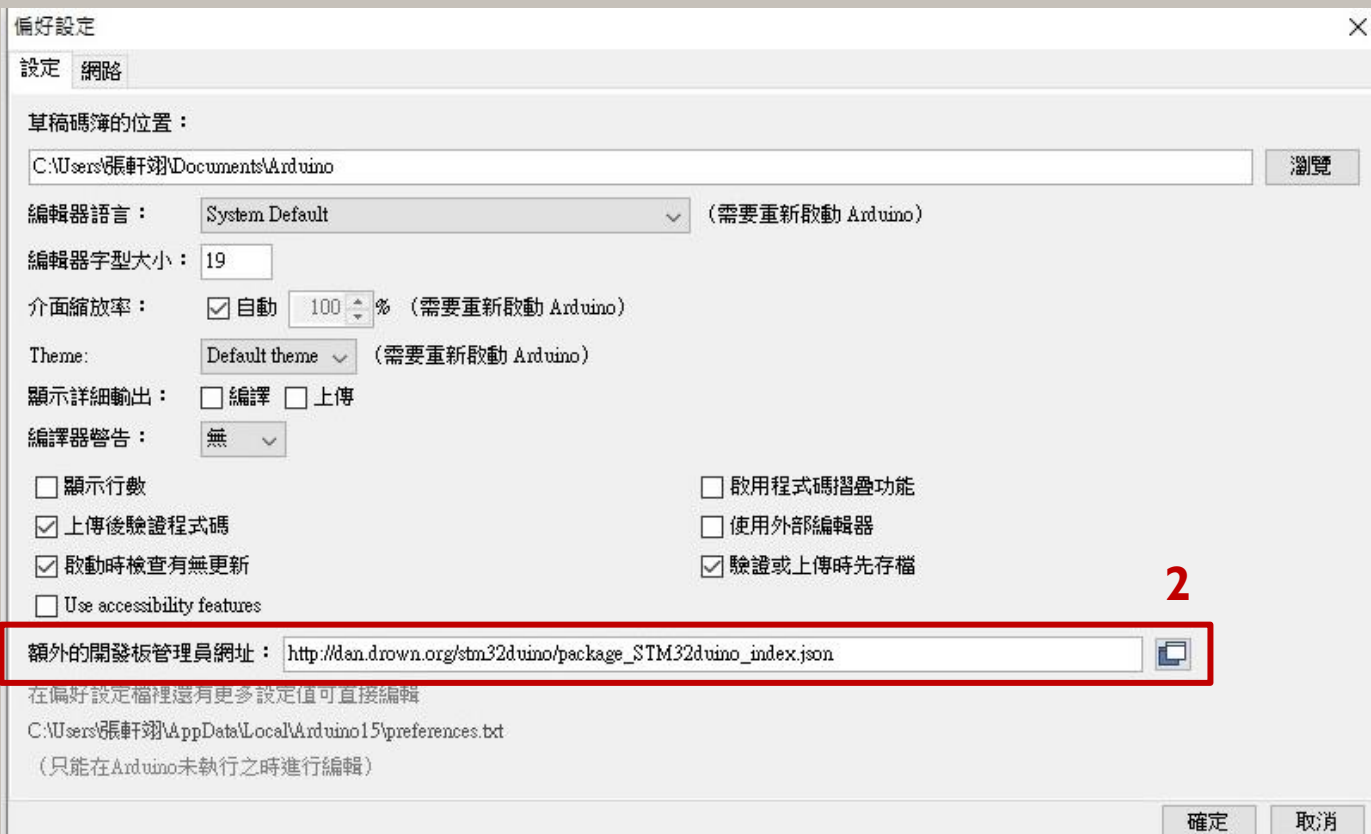
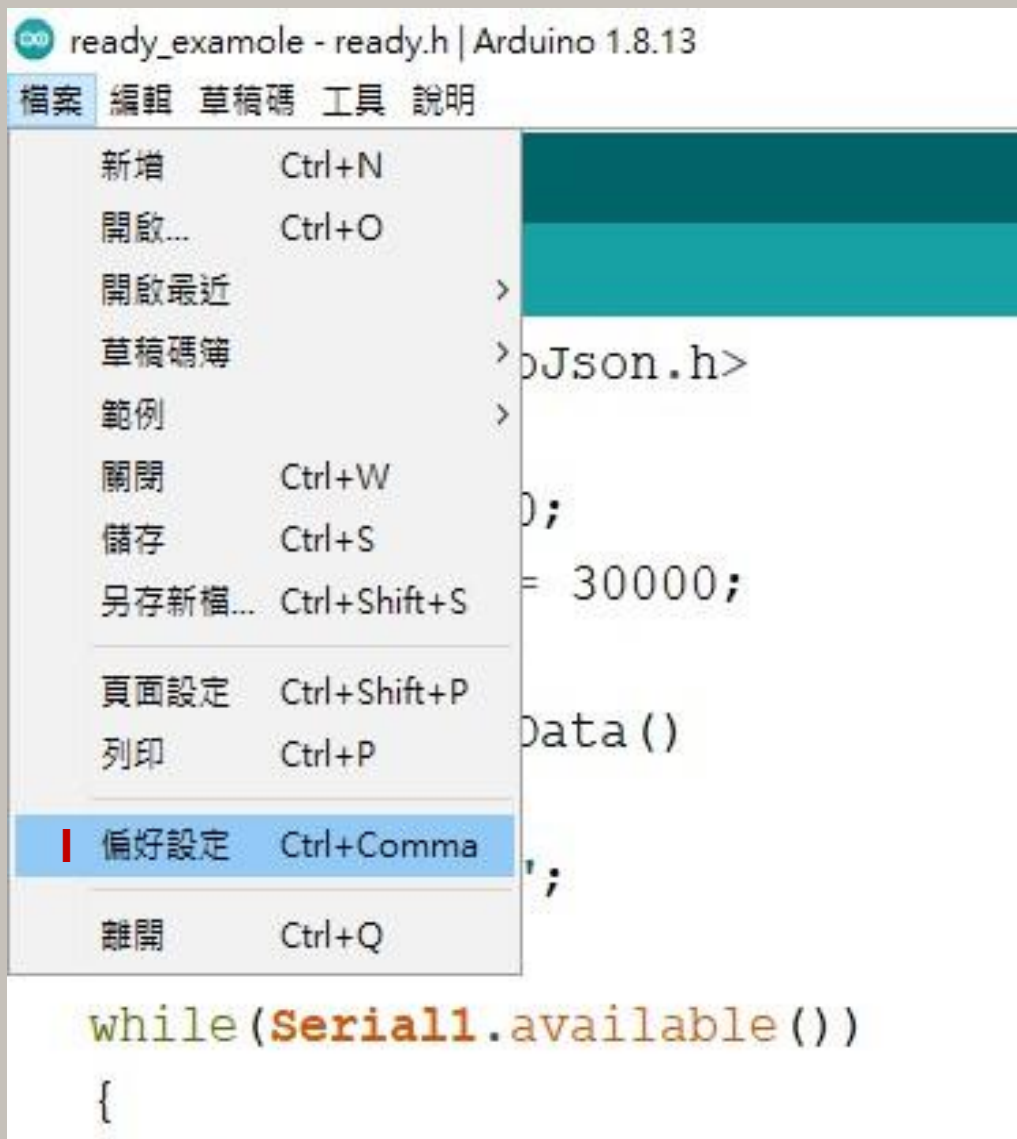

首先從檔案中點選偏好設定後可看到上方之視窗，並在額外增加開發板管理員中輸入以下網址：
http://dan.drown.org/stm32duino/package_STM32duino_index.json

3-1 開發環境及APN設定

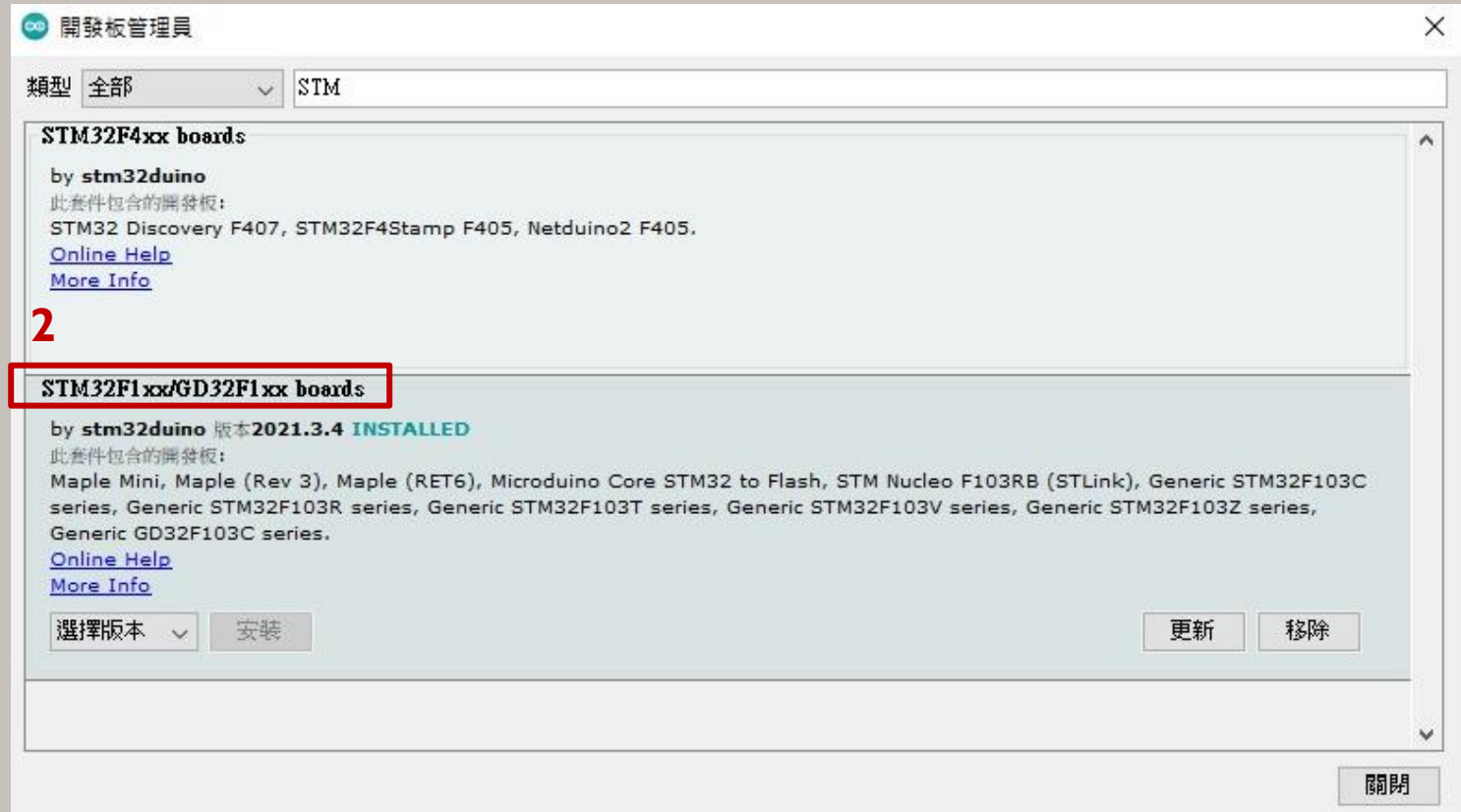
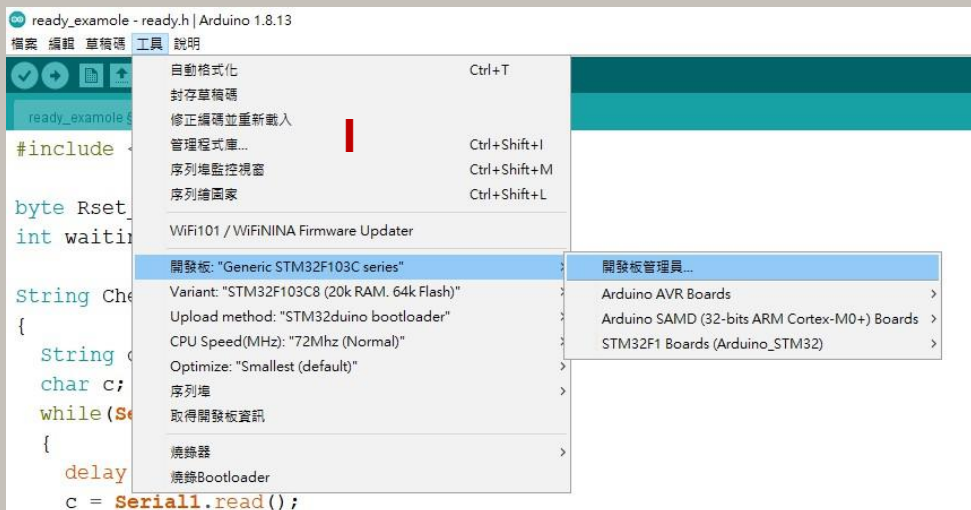

點選工具 -> 開發板 -> 開發版管理員
以下載開發板資訊



3-1 開發環境及APN設定

Driver安裝(抓不到開發板時安裝)

安裝DFU windows的driver，從以下網址下載：

https://github.com/rogerclarkmelbourne/Arduino_STM32

解開Arduino_STM32-master.zip 之後，到目錄下Arduino_STM32-master\drivers\win以系統管理者執行這程式install_drivers.bat來自動安裝DFU driver。

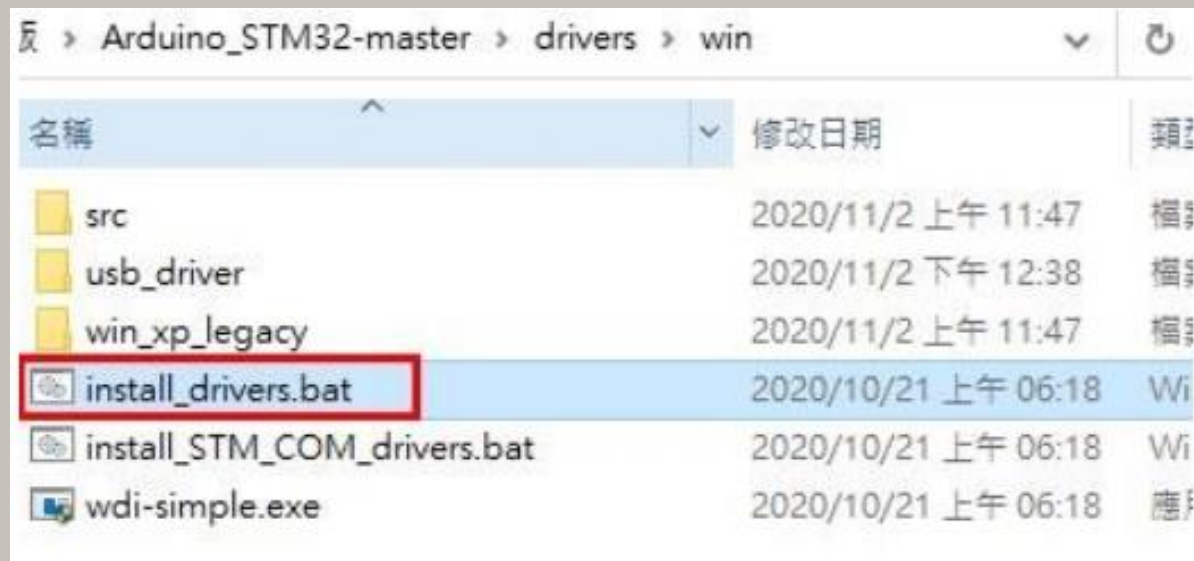

3-1 開發環境及APN設定

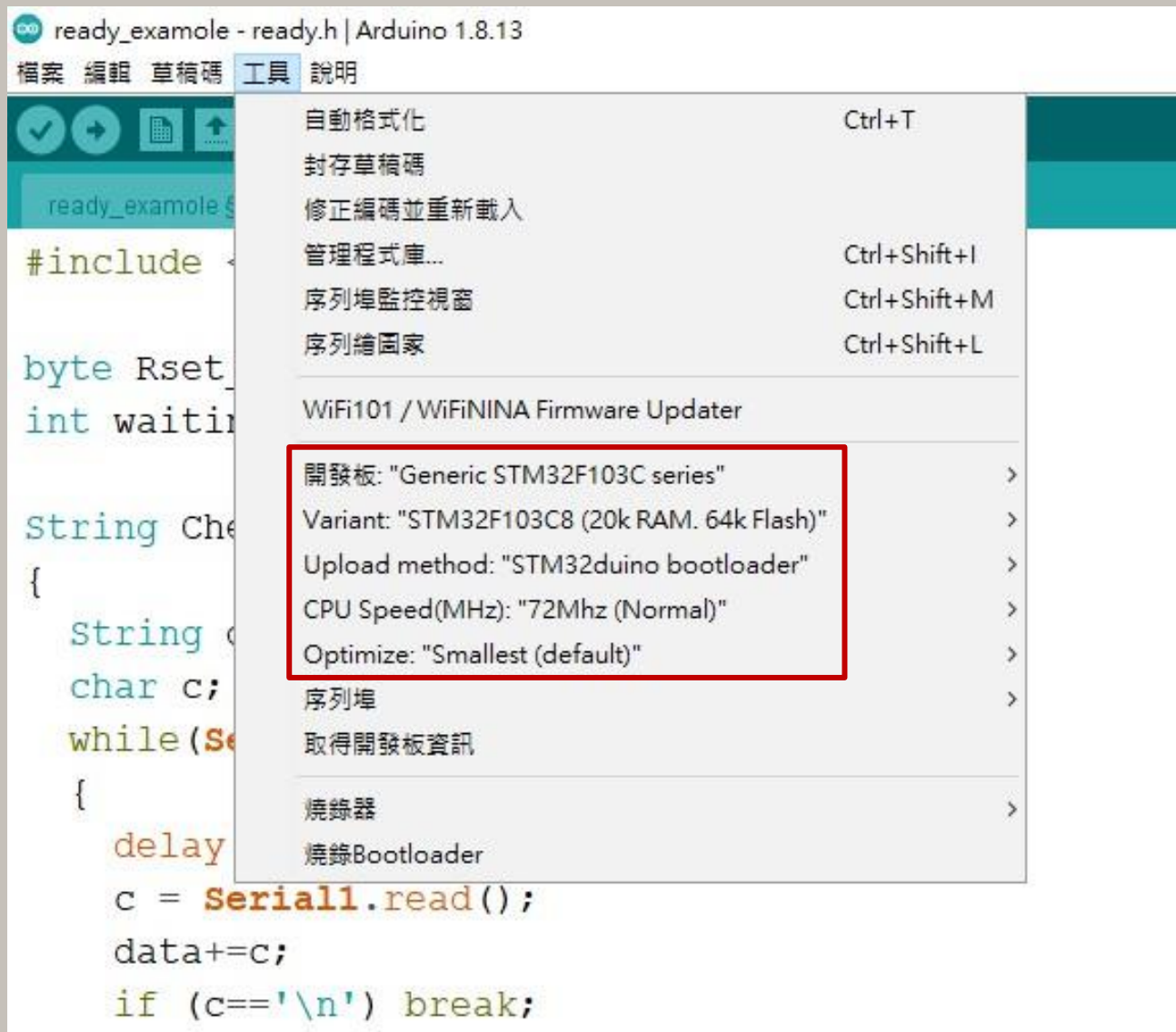

請勿任意更改設定，會導致系統無法取得開發板資訊 (Maple Mini)



3-1 開發環境及APN設定

資料來源：資策會

程式碼下載: <https://t.ly/lbip>

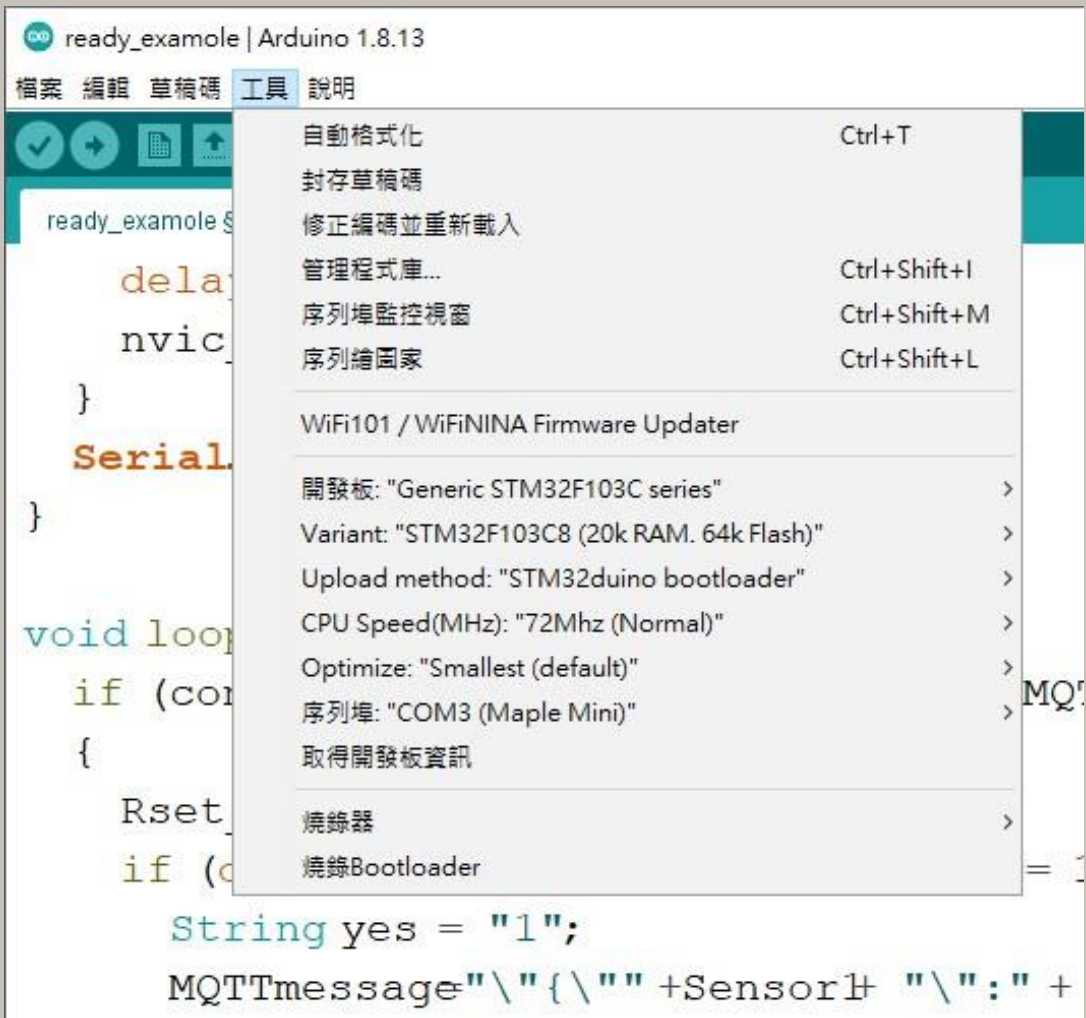

STEP 1：打開main.ino，並至Arduino的工具->序列埠中找到相對應之COM PORT編號。

STEP 2：
工具 ->開發板->Generic STM32F103C series，
並且按下上傳 將程式燒錄進去。

3-1 開發環境及APN設定

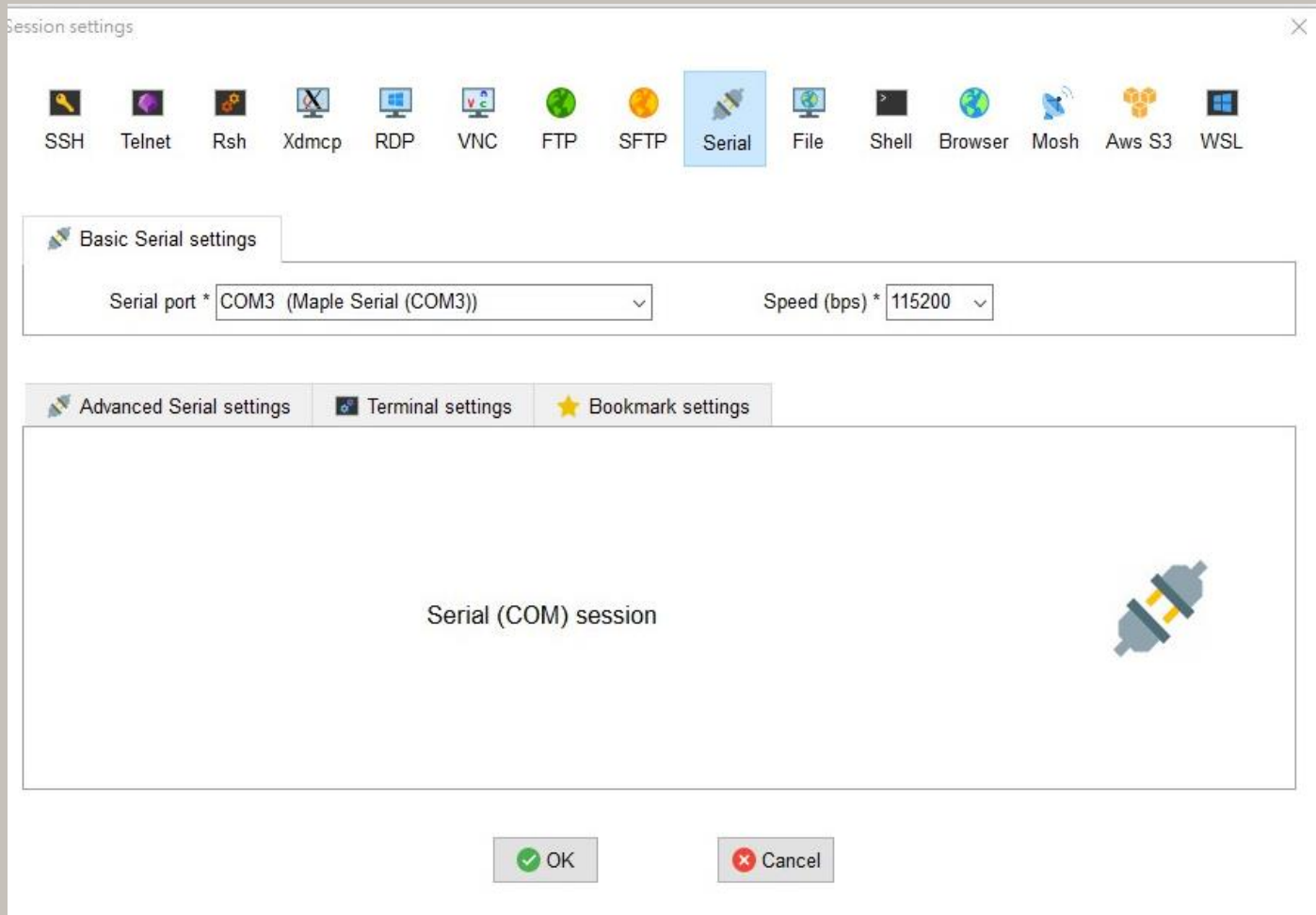

MobaXterm有連接較穩定之優點，因此本操作範例利用MobaXterm來代替Arduino之Serial序列埠監控視窗。

操作上於Serial中選擇對應之port和Speed即可觀測。

3-1 開發環境及APN設定

Home Edition

Free

Full **X server** and **SSH** support
Remote desktop (RDP, VNC, Xdmcp)
Remote terminal (SSH, telnet, rlogin, Mosh)
X11-Forwarding
Automatic SFTP browser
Master password protection
Plugins support
Portable and installer versions
Full documentation
Max. **12** sessions
Max. **2** SSH tunnels
Max. **4** macros
Max. **360** seconds for Tftp, Nfs and Cron



Download now



MobaXterm Home Edition v21.2
(Installer edition)

MobaXterm之取得方法十分簡單

步驟一：搜尋MobaXterm網頁。

步驟二：選擇下載免費版本。

步驟三：點選綠色底部之版本開始下載。

3-1 開發環境及APN設定

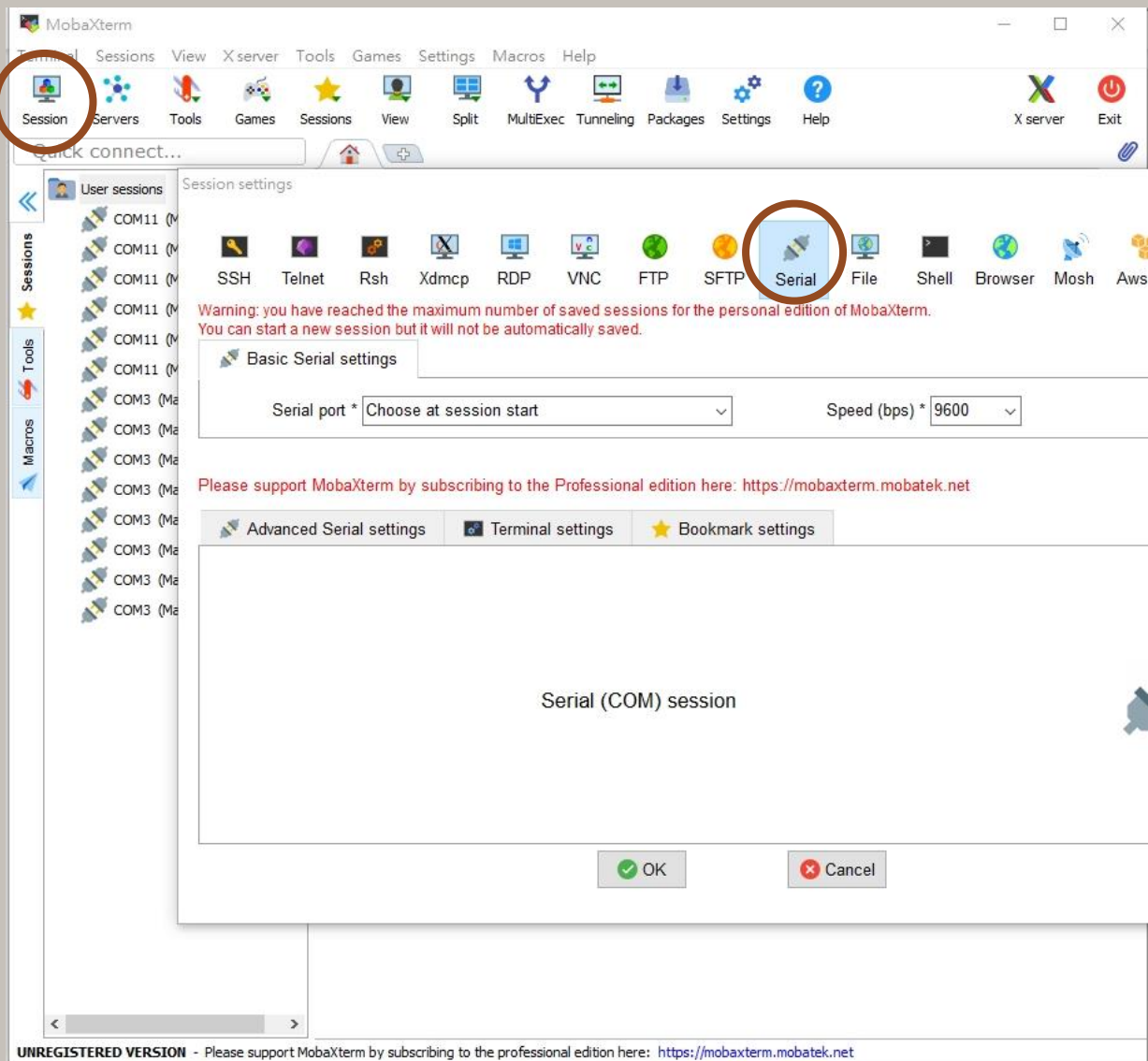

開啟MobaXterm，點選左上角之Session，並點選跳出視窗之Serial。選擇所在之Serial port 和Speed即可運作。

3-1 開發環境及APN設定

資料來源：資策會

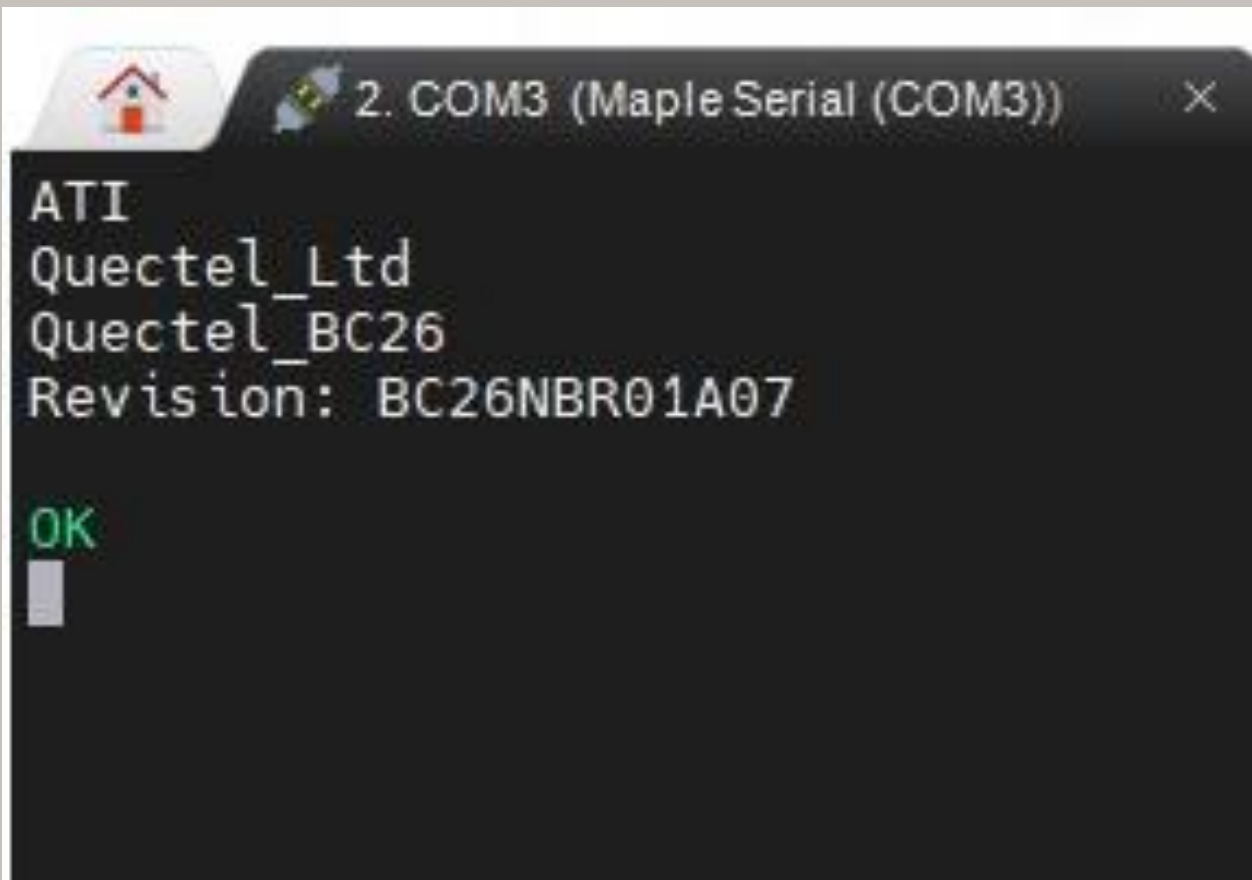

```
ATI
Quectel_Ltd
Quectel_BC26
Revision: BC26NBR01A07

OK
```

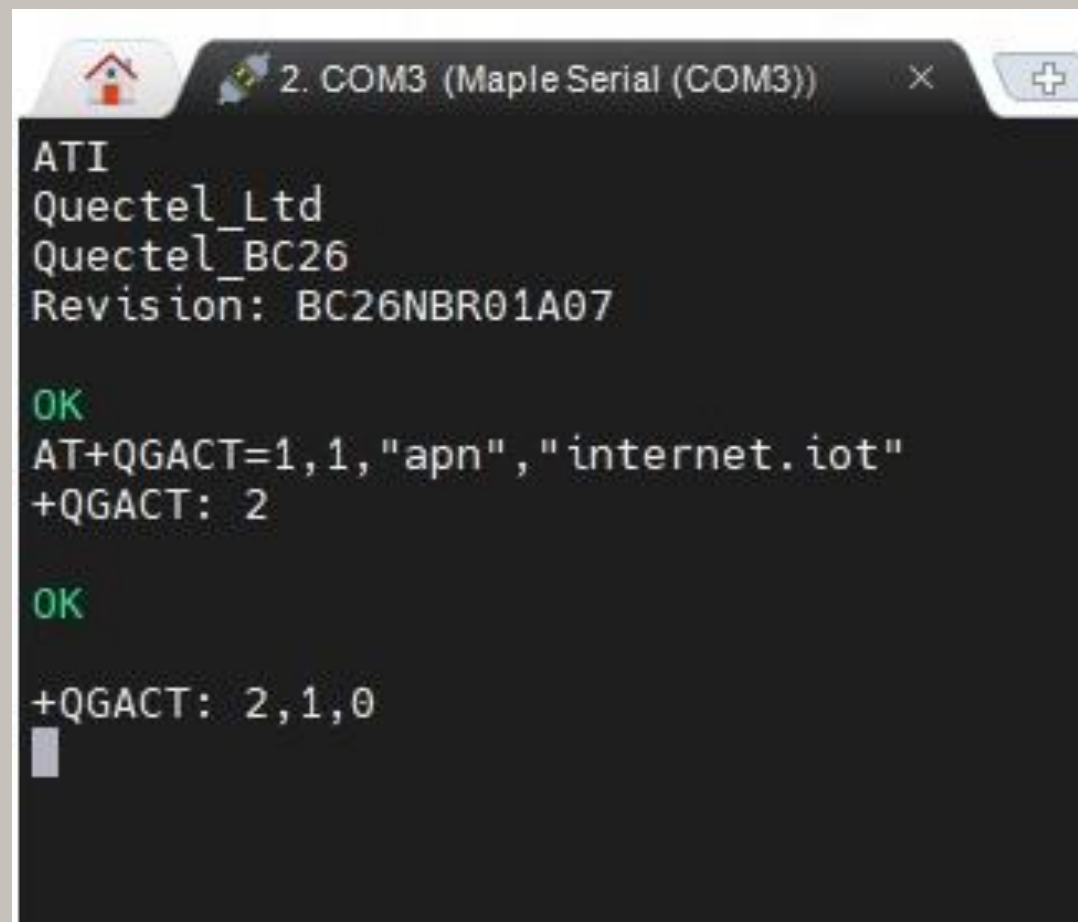

```
ATI
Quectel_Ltd
Quectel_BC26
Revision: BC26NBR01A07

OK
AT+QGACT=1,1,"apn","internet.iot"
+QGACT: 2

OK

+QGACT: 2,1,0
```

STEP 3：開啟MobaXterm，在上方輸入欄中輸入ATI 指令，可先輸入「ATI」，查看模組是否有回覆版本訊息。

STEP 4：啟用APN：AT+QGACT=1,1,"apn","internet.iot"(此為中華電信SIM卡代碼)

3-1 開發環境及APN設定

資料來源：資策會

```
ATI
Quectel_Ltd
Quectel_BC26
Revision: BC26NBR01A07

OK
AT+QGACT=1,1,"apn","internet.iot"
+QGACT: 2

OK

+QGACT: 2,1,0
AT+QCGDEFCONT="IP","internet.iot"
OK
█
```

```
ATI
Quectel_Ltd
Quectel_BC26
Revision: BC26NBR01A07

OK
AT+QGACT=1,1,"apn","internet.iot"
+QGACT: 2

OK

+QGACT: 2,1,0
AT+QCGDEFCONT="IP","internet.iot"
OK
AT+QBAND=1,8

OK
█
```

```
AT+QRST=1
F1: 0000 0000
V0: 0000 0000 [0001]
00: 0006 000C
01: 0000 0000
U0: 0000 0001 [0000]
T0: 0000 00B4
Leaving the BROM

F1: 0000 0000
V0: 0000 0000 [0001]
00: 0006 000C
01: 0000 0000
U0: 0000 0001 [0000]
T0: 0000 00B4
Leaving the BROM

RDY

+CFUN: 1

+CPIN: READY

+IP: 10.176.84.80
█
```

STEP 5 : 註冊APN :

AT+QCGDEFCONT="IP","internet.iot"

STEP 6 : 頻寬設定 : AT+QBAND=1,8

STEP 7 : 重新啟動模組 : AT+QRST=1



3-1 開發環境及APN設定

資料來源：資策會

設定檢查：

STEP 1：Sim卡狀態查詢：AT+CPIN?

回覆：

READY，表示有找到SIM卡回覆

ERROR，表示沒有SIM卡。

STEP 2：APN狀態查詢：AT+CEREG?

回覆：

+CEREG= 0,1，表示已經進入APN的網域。

+CEREG= 0,2，表示尚未註冊APN的網域。

+CEREG= 0,0，表示沒有SIM卡。

```
RDY
+CFUN: 1
+CPIN: READY
+IP: 10.176.84.80
AT+CPIN?
+CPIN: READY

OK
AT+CEREG?
+CEREG: 0,1

OK
```

3-1 開發環境及APN設定

資料來源：資策會

STEP 3：訊號強度查詢：
AT+CESQ 回覆：+CESQ：
xx, 0, 255, 255, 255 xx：0~99，
0：未有訊號，99：找不到
訊號。

STEP 4：IP查詢：
AT+CGPADDR=1 回覆：OK：
尚未找到IP 回覆：
+CGPADDR: 1, IP(四位)：表
示已有IP說明：若設定期間
連上網路會自動回傳IP位址
+IP：IP位址。

```
+CPIN: READY
+IP: 10.176.84.80
AT+CPIN?
+CPIN: READY
OK
AT+CEREG?
+CEREG: 0,1
OK
AT+CESQ
+CESQ: 23,0,255,255,22,45
OK
```

```
RDY
+CFUN: 1
+CPIN: READY
+IP: 10.176.84.80
AT+CPIN?
+CPIN: READY
OK
AT+CEREG?
+CEREG: 0,1
OK
AT+CESQ
+CESQ: 23,0,255,255,22,45
OK
AT+CGPADDR=1
+CGPADDR: 1,10.176.84.80
OK
```

3-1-1 平台設定及配置

IDEAS Chain 網站的平台設定與 API 使用教學 請參考下列網址：
<https://iforum.ideaschain.com.tw/iforum/devtool/board.do?board=3>

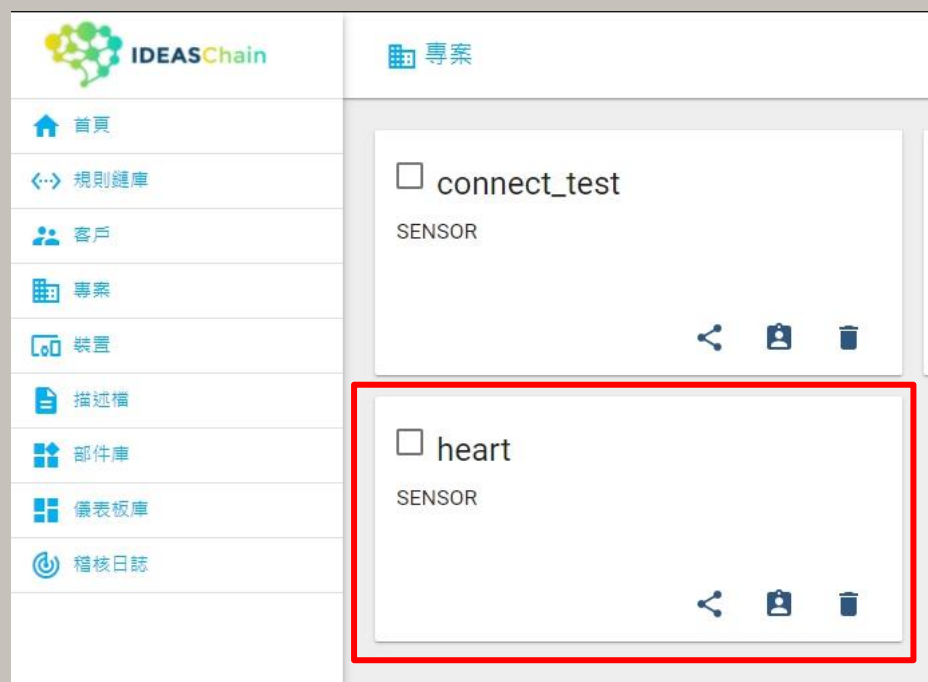

於IDEAS Chain 網站的平台建立專案及裝置

3-2-1 程式介紹-BC26_init.h

```
#include <ArduinoJson.h>

byte Rset_Count=0;           //系統重新啟動計時器宣告
int waitingTime = 30000;    //等候30秒的回覆

String Check_RevData ()     //讀取收到的每一字元資料，彙整成一個字串
{
    String data= "";
    char c;
    while(Serial1.available())
    {
        delay(50);
        c = Serial1.read(); //讀取開發板的回應
        data+=c;           //將讀取到的回應存在字串data中
        if (c=='\n') break;
    }
    data.trim();          //將字串中多餘的字串去除，包括空格、Enter、Tab等
    return data;         //返回data字串
}
```

Check_RevData函式將字元轉字串，使其符合平台接收格式(串列)

3-2-1 程式介紹-BC26_init.h 指令傳送

```
byte Send_ATcommand(String msg, byte stepnum) //傳送AT command,並加以判斷
{
    String Showmsg, C_temp;
    Serial.println(msg);
    Serial1.println(msg);
    Showmsg=Check_RevData();
    //Serial.println(Showmsg); //將開發版的回應顯示於監視窗

    long StartTime=millis();
    switch (stepnum)
    {
        case 0: //重置 BC26
            C_temp = "+IP:";
            break;
        case 1: //其他Data
            C_temp = "OK";
            break;
        case 2: //確認獲得的IP位置
            C_temp = "+CGPADDR:";
            break;
        case 10: //建立MQTT Server
            C_temp = "+QMTOPEN: 0,0";
            break;
        case 11: //以username和password連線MQTT Server
            C_temp = "+QMTCONN: 0,0,0";
    }
}
```

建立指令：使操作者能從指令得知哪階段有問題或是程式進行到哪裡

3-2-1 程式介紹-BC26_init.h 指令傳送

```
case 12:                //Publisher MQTT Data
    C_temp = "+QMTPUB: 0,0,0";
    break;
case 13:                //Subscribe MQTT Data
    C_temp = "+QMTPSUB: 0,1,0,0";
    break;
}
while (!Showmsg.startsWith(C_temp))
{
    Showmsg = Check_RevData();
    if (Showmsg.startsWith("+")) Serial.println(Showmsg);
    if ((StartTime + waitingTime) < millis()) return stepnum;
}
return 99;
}
```

建立指令：
使操作者能
從指令得知
哪階段有問
題或是程式
進行到哪裡

3-2-1 程式介紹-BC26_init.h

初始化 DSI2598+ 之 BC26init()

```
bool BC26init()    // 初始化 BC26
{
    Send_ATcommand("AT+QGACT=1,1,\"apn\",\"internet.iot\"", 1); // "internet.iot" 隨基地台不同而不同
    Send_ATcommand("AT+QCGDEFPCOUNT=\"IP\",\"internet.iot\"", 1); // "internet.iot" 隨基地台不同而不同
    Send_ATcommand("AT+QBAND=1,8", 1);
    Send_ATcommand("AT+QRST=1", 0);
    if (Send_ATcommand("ATE0", 1) == 99)
    if (Send_ATcommand("AT+CGPADDR=1", 2) == 99) return true;
    return false;
}
```

- 中華電信NB-IoT服務的APN : "internet.iot"
- 遠傳電信APN : "nbiot"
- 台灣大哥大APN : "twm.nbiot"



3-2-1 程式介紹-BC26_init.h

連線 MQTT Broker connect_MQTT()

```
bool connect_MQTT(String Serverx, String port, String user, String pass)//建立MQTT連線通道
{
    String S_temp;
    S_temp = "\"" + Serverx + "\" + \",\" + port;
    S_temp = "AT+QMTOPEN=0," + S_temp;
    if (Send_ATcommand(S_temp, 10) != 99) return false;
    S_temp = "\"" + user + "\" + \",\" + "\"" + pass + "\"";
    S_temp = "AT+QMTCONN=0,0," + S_temp;
    if (Send_ATcommand(S_temp, 11) != 99) return false;
    return true;
}
```

3-2-1 程式介紹-BC26_init.h

```
bool Publish_MQTT(String topic, String message)//發布資料
{
  String S_temp;
  S_temp = "\"" + topic + "\"" + "," + message;
  S_temp = "AT+QMTPUB=0,0,0,0,"+S_temp;
  if (Send_ATcommand(S_temp,12) !=99) return false;
  return true;
}
```

發布資料 Publish_MQTT ()
將想要的資料傳至平台

```
bool Sub_MQTT(String topic)//訂閱資料
{
  String S_temp;
  S_temp="\""+topic+"\""+","+"0";
  S_temp="AT+QMTPSUB=0,1,"+S_temp;
  if(Send_ATcommand(S_temp,13) !=99) return false;
  return true;
}
```

訂閱資料 Sub_MQTT () 函式
從平台上獲得資料



3-2-1 程式介紹-BC26_init.h

關閉與 MQTT Broker 的連線 Close_MQTT()

```
bool Close_MQTT() //關閉連線
{
    String S_temp;
    S_temp="AT+QMTCLOSE=0";
    if(Send_ATcommand(S_temp,1)!=99) return false;
    return true;
}
```



3-2-1 程式介紹-BC26_init.h

將讀到 IDEAS Chain 網站的屬性資料 JSON 格式，進行分解取出 JSON_DEC_data()

```
String JSON_DEC_data(String input, String findData)//將包含JSON格式的資料取出
{
    int index=input.indexOf(',');
    int x=input.substring(0, index).toInt();
    String json=input.substring(index+1,input.length());
    index=json.indexOf(':');
    x=json.substring(0,index).toInt();
    json=json.substring(index+1,json.length());
    DynamicJsonDocument doc(1024);
    deserializeJson(doc, json);
    JsonObject obj=doc.as<JsonObject>();
    return obj[findData];
}
```

MQTT需使用JSON
格式進行傳輸



3-2-1 程式介紹-BC26_init.h

取出 IDEAS Chain 網站資料時，必須先執行訂閱的動作 Sub_Ideaschain()

```
bool Sub_Ideaschain(String attrestopic)//訂閱Ideaschain屬性資料
{
    String S_temp;
    S_temp = "\"" + attrestopic + "\" + \",\" + \"0\";
    S_temp = "AT+QMTSUB=0,1," + S_temp;
    Serial.println(S_temp);
    Serial1.println(S_temp);
    delay (2000);
    return true;
}
```

```

String Get_Publish_MQTT(byte mode, String attreqtopic, String message)//取得Ideaschain屬性資料
{
  String Showmsg;
  String S_temp, T_temp;
  if (mode==0) T_temp="sharedKeys";
  if (mode==1) T_temp="clientKeys";
  S_temp="\\"+attreqtopic+"\\"+", "+\\"{"+T_temp+"\\":\\""+message+"\\"}\\"";
  S_temp="AT+QMQTPUB=0,0,0,0,"+S_temp;
  Serial.println(S_temp);
  Serial1.println(S_temp);
  Showmsg=Check_RevData();
  long StartTime=millis();
  while(!Showmsg.startsWith("+QMQTRECIV:"))
  {
    delay(1000);
    Showmsg=Check_RevData();
    if(Showmsg.length()>30) break;
    if((StartTime+waitingTime)<millis()) return "error";
  }
  return JSON_DEC_data (Showmsg,message);
}

```

訂閱後所取得的
IDEAS Chain 屬性資料
Get_Publish_MQTT()

*本範例不會使用



3-2-2 程式介紹- main.ino

```
#include "BC26_init.h"
#include <Wire.h>
#include "MAX30105.h"

#include "heartRate.h"
```

引用函式庫，用於控制心跳模組

```
MAX30105 particleSensor;
```

```
const byte RATE_SIZE = 4; //Increase this for more averaging. 4 is good.
byte rates[RATE_SIZE]; //Array of heart rates
byte rateSpot = 0;
long lastBeat = 0; //Time at which the last beat occurred
```

```
float beatsPerMinute;
int beatAvg;
```

```
String MQTT_Server="iiot.ideaschain.com.tw"; //MQTT Server的IP位址 IP of MQTT server
String MQTT_Port="1883"; //MQTT使用的port (固定的勿更動) MQTT's port (donot change)
String MQTT_Access_token="2WrR4ajdMIVAS0okbLsb" //使用者密碼-->Ideaschain裝置的存取權杖 User password-> TOKEN form IDEAS Chain platform
String MQTTtopic="v1/devices/me/telemetry"; //Ideaschain固定路徑 IDEAS Chain fixed path
String MQTTmessage=""; //發佈到Ideaschain的字串 The string publish to IDEAS Chain

String Sensor1="heart_rate"; //平台接收的變數名稱 The variable name for platform
```

權杖可由IDEAS Chain之專案裝置獲取

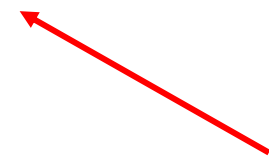



3-2-2 程式介紹- main.ino

```
void setup()
{
  Serial.begin(115200);
  Serial1.begin(115200);
  Serial.println("Initializing...");

  // Initialize sensor
  if (!particleSensor.begin(Wire, I2C_SPEED_FAST)) //Use default I2C port, 400kHz speed
  {
    Serial.println("MAX30105 was not found. Please check wiring/power. ");
    while (1);
  }
  Serial.println("Place your index finger on the sensor with steady pressure.");

  particleSensor.setup(); //Configure sensor with default settings
  particleSensor.setPulseAmplitudeRed(0x0A); //Turn Red LED to low to indicate sensor is running
  particleSensor.setPulseAmplitudeGreen(0); //Turn off Green LED
}

int buzzPin = PB10;
int i = 0;
```

心跳感測器之設定

蜂鳴器腳位之設定

3-2-2 程式介紹- main.ino

```
if(!BC26init()) //引用BC26初始化函式 Quote the Initialize function BC26
{
  delay(30000);
  nvic_sys_reset();
}
Serial.println("初始化完成....");

void loop()
{
  long irValue = particleSensor.getIR();

  if (checkForBeat(irValue) == true)
  {
    //We sensed a beat!
    long delta = millis() - lastBeat;
    lastBeat = millis();

    beatsPerMinute = 60 / (delta / 1000.0);

    if (beatsPerMinute < 255 && beatsPerMinute > 20)
    {
      rates[rateSpot++] = (byte)beatsPerMinute; //Store this reading in the array
      rateSpot %= RATE_SIZE; //Wrap variable

      //Take average of readings
      beatAvg = 0;
      for (byte x = 0 ; x < RATE_SIZE ; x++)
        beatAvg += rates[x];
      beatAvg /= RATE_SIZE;
    }
  }
}
```

平均心跳之計算



3-2-2 程式介紹- main.ino

```
if (irValue < 50000){  
  Serial.println(" No finger?");  
}  
  
if (beatsPerMinute < 80 && beatsPerMinute > 60){  
  if (connect_MQTT(MQTT_Server, MQTT_Port, MQTT_Access_token, MQTT_Access_token)) { //以MQTT連線Ideaschain平台   Connect IDEAS Chain by MQTT  
    Serial.print("BPM=");  
    Serial.print(beatsPerMinute);  
    Serial.print(", Avg BPM=");  
    Serial.println(beatAvg);  
    Rset_Count++;  
    String BPM;  
    BPM.concat(beatsPerMinute);  
    MQTTmessage = "\"" + Sensor1 + "\": " + BPM + "\""; //設定發佈資料   Set the publish data  
    Publish_MQTT(MQTTtopic, MQTTmessage);  
  }  
  Close_MQTT();  
}
```

心跳正常值設置
即顯示數據設置

發佈置平台之資料設定，心跳狀態。



3-2-2 程式介紹- main.ino

```
if (beatsPerMinute > 120) {  
  for (i=0; i<5; i++) {  
    digitalWrite (buzzPin, HIGH);  
    delay (1000);  
    digitalWrite (buzzPin, LOW);  
    delay (1000);  
  }  
}
```

心跳異常蜂鳴器鳴響

```
if (connect_MQTT (MQTT_Server, MQTT_Port, MQTT_Access_token, MQTT_Access_token)) { //以MQTT連線Ideaschain平台 Connect IDEAS Chain by MQTT  
  Serial.print ("BPM=");  
  Serial.print (beatsPerMinute);  
  Serial.print (" , Avg BPM=");  
  Serial.println (beatAvg);  
  Rset_Count++;  
  String BPM;  
  BPM.concat (beatsPerMinute);  
  MQTTmessage = "\"" + Sensor1 + "\": " + BPM + "\""; //設定發佈資料 Set the publish data  
  Publish_MQTT (MQTTtopic, MQTTmessage);  
}  
Close_MQTT ();  
}  
  
if (Rset_Count > 20) {  
  delay (10000); nvic_sys_reset ();  
}  
}
```

第四章

成果展示

電路圖

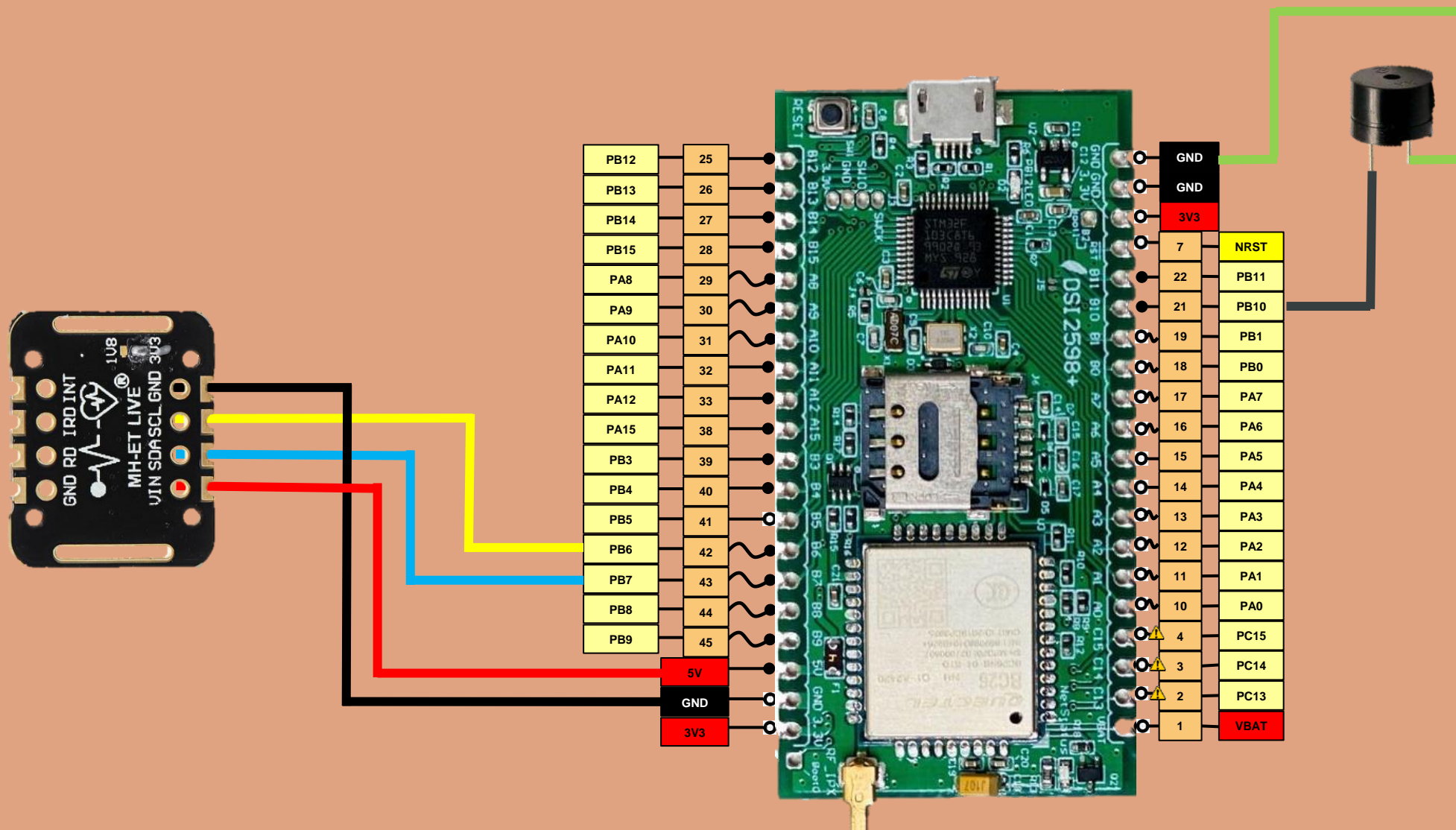

訊號顯示成果

MobaXterm之訊號顯示結果：

“heart_rate”： 表示量測之心跳值

No finger 表示手指間放置感測器測量

```
+QGACT: 2
AT+QCGDEFPCOUNT="IP","internet.iot"
+QGACT: 2,1,0
AT+QBAND=1,8
AT+QRST=1
+CFUN: 1
+CPIN: READY
+IP: 10.212.91.124
初始化完成....
AT+QMTOPEN=0,"iiot.ideaschain.com.tw",1883
+QMTOPEN: 0,0
AT+QMTCONN=0,0,"2WrR4ajdMIVAS0okbLsb","2WrR4a+QMT PUB: 0,0,0
AT+QMTCLOSE=0
AT+QMTOPEN=0,"iiot.ideaschain.com.tw",1883
+QMTOPEN: 0,0
AT+QMTCONN=0,0,"2WrR4ajdMIVAS0okbLsb","2WrR4ajdMIVAS0okbLsb"
+QMTCONN: 0,0,0
BPM=79.05, Avg BPM=19
AT+QMT PUB=0,0,0,0,"v1/devices/me/telemetry" {"heart_rate":79.05}"
```

```
No finger?
No finger?
AT+QMTOPEN=0,"iiot.ideaschain.com.tw",1883
+QMTOPEN: 0,0
AT+QMTCONN=0,0,"2WrR4ajdMIVAS0okbLsb","2WrR4ajdMIVAS0okbLsb"
+QMTCONN: 0,0,0
BPM=69.85, Avg BPM=17
AT+QMT PUB=0,0,0,0,"v1/devices/me/telemetry" {"heart_rate":69.85}"
+QMT PUB: 0,0,0
AT+QMTCLOSE=0
AT+QMTOPEN=0,"iiot.ideaschain.com.tw",1883
+QMTOPEN: 0,0
AT+QMTCONN=0,0,"2WrR4ajdMIVAS0okbLsb","2WrR4ajdMIVAS0okbLsb"
+QMTCONN: 0,0,0
BPM=69.85, Avg BPM=17
AT+QMT PUB=0,0,0,0,"v1/devices/me/telemetry" {"heart_rate":69.85}"
█
```

平台成果

IDEAS Chain平台之訊號顯示結果：
從平台中可得到心跳數據、時間。
上圖為將數據圖表化之結果

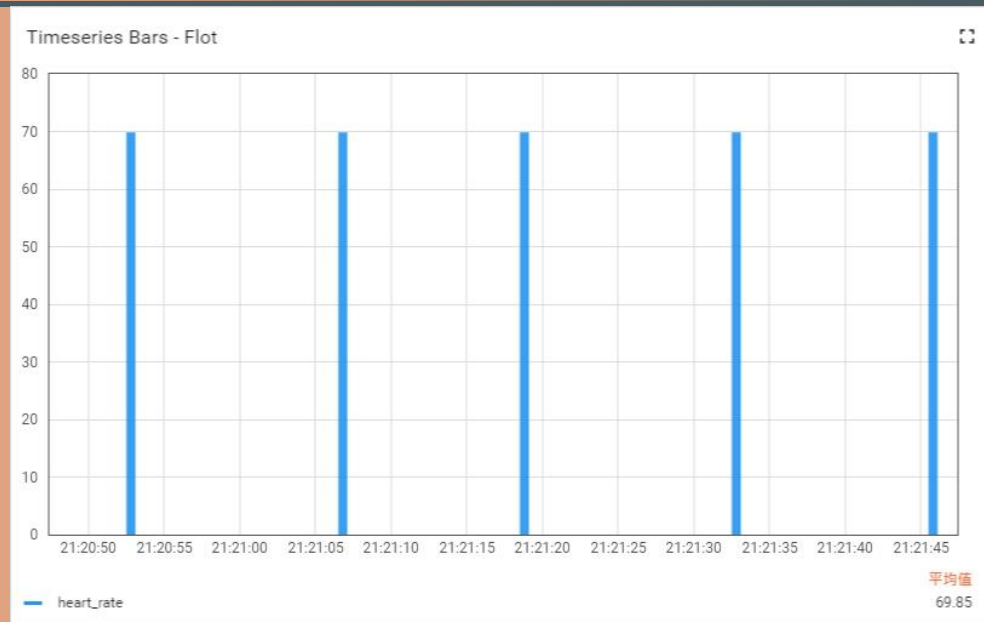

Timeseries table

🕒 即時 - 最後分

心跳數據

Timestamp ↓

Timestamp	heart_rate
2021-05-29 21:21:58	69.85
2021-05-29 21:21:45	69.85
2021-05-29 21:21:32	69.85
2021-05-29 21:21:18	69.85
2021-05-29 21:21:06	69.85

紀錄時間

成果示意圖

示意圖



醫院

傳統



醫護人員

以大量人力量測及
監控病患生理數值



智慧醫療



MAX30102
心跳血氧感測

以心跳血氧模組量
測病患生理數值



病患生理訊號心跳

DSI2598+



病患生理訊號異常
(心跳太快)

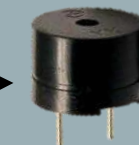

蜂鳴器

蜂鳴器鳴叫提醒異常



病人數值異常時投入醫護人員應對以
減少人力耗損及提升醫院服務效率。

心跳訊號監測

